

FACTORY AUTOMATION

MELSEC iQ-F
series

MELSEC iQ-F Series iQ Platform-compatible PLC

FX5S-30M□/□, FX5S-40M□/□, FX5S-60M□/□



New **FX5S**

MELSEC iQ-F lineup

Abundant lineup for manufacturing site.

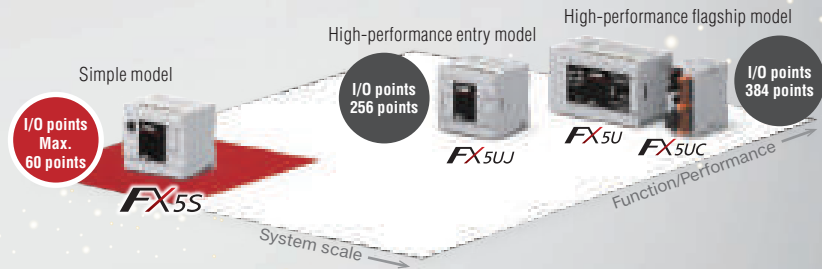

System configuration

Expansion adapter and expansion board can be used, aiming for easy and simple configuration.

Expansion adapter

Max. 6 modules in total

Analog adapter*1

Analog input
FX5-4AD-ADP 4 ch 14-bit

Analog output
FX5-4DA-ADP 4 ch 14-bit

Analog input/output
FX5-4A-ADP 2 ch 2 ch 14-bit

For resistance temperature detector input
FX5-4AD-PT-ADP 4 ch 0.1°C

For thermocouple input
FX5-4AD-TC-ADP 4 ch 0.1°C*3

Max. 4 modules*2

Communication adapter

For RS-232C communication
FX5-232ADP 1 ch

For RS-485 communication
FX5-485ADP 1 ch

Max. 2 modules*4

CPU module

Expansion board

Max. 1 module

SD memory card module
FX5-SDCD **NEW**

Logging files can be stored in SD memory cards.
Can be used together with other expansion boards.
The cover part can be cut off and mounted on top of another expansion board.

For RS-232C communication
FX5-232-BD 1 ch

For RS-485 communication
FX5-485-BD 1 ch

For RS-422 communication (For GOT connection)
FX5-422-BD-GOT 1 ch

Max. 1 module

*1: There are restrictions on the order of connection for some models. For details, refer to the MELSEC iQ-F FX5S/FX5UJ/FX5U/FX5UC User's Manual (Hardware).
 *2: For FX5-4A-ADP, maximum of two modules when the serial number is 223**** or earlier.
 *3: When using K, J, or T type thermocouples. Resolution of B, R, and S type thermocouples is 0.1 to 0.3°C.
 *4: Maximum of one module when expansion board (for RS-232C/RS-485/RS-422 communication) is connected to the CPU module.

■ Number of input channels ■ Number of output channels
 ■ Minimum resolution ■ Number of connectable channels

Advantages 2 Small-scale IoT with simple model

- Strength of FX5S
- ☑ The CPU module has a built-in maintenance functions and communication connectivity with various devices necessary for IoT of equipments and machines.
- ☑ Further expansion of IoT functions (data collection, remote monitoring, etc.) is also possible.*1



Table of main functions supported by FX5S

(For details, refer to the next page.)

Function		CPU module only	With SD memory card module connected	Number of connectable modules
Communication connection	Simple CPU communication	○		8 modules
	CC-Link IE Field Network Basic	○		8 modules
	MELSOFT connection	○		Total 8 modules
	SLMP	○		
	Predefined protocol support	○		
	Socket communication	○		
Security	MODBUS/TCP communication	○		
	Block password	○		—
	File password	○		—
	Remote password	○		—
	Security key authentication	○		—
Data collection	IP filter	○		—
	Data logging		○	—
	FTP server		○	Total 1 module
	FTP client		○	
Remote monitoring	Web server (System Web page)	○		—
	Web server (User Web page)		○	—
	Data flow analysis	○		—
Maintenance	Real-time monitoring	○		1 module
	Memory dump		○	—
	Backup/restore		○	—
	Event history	○	○*2	—
	Firmware update*3	○	○	—
Others	Sntp client	○		1 module
	File operation instruction		○	—
	Boot operation		○	—

*1: It may be necessary to connect the SD memory card module in some cases. For details, refer to the table above.
 *2: When storage location is SD memory card.
 *3: Firmware updates can be performed directly using GX Works3 by connecting a PC to the CPU module. Firmware updating can also be performed by storing the firmware update file in an SD memory card and inserting it into the SD memory card module.

Achieve IoT using **FX5S**

Start IoT of your equipment using FX5S. IoT can be introduced utilizing the internal functions of FX5S.

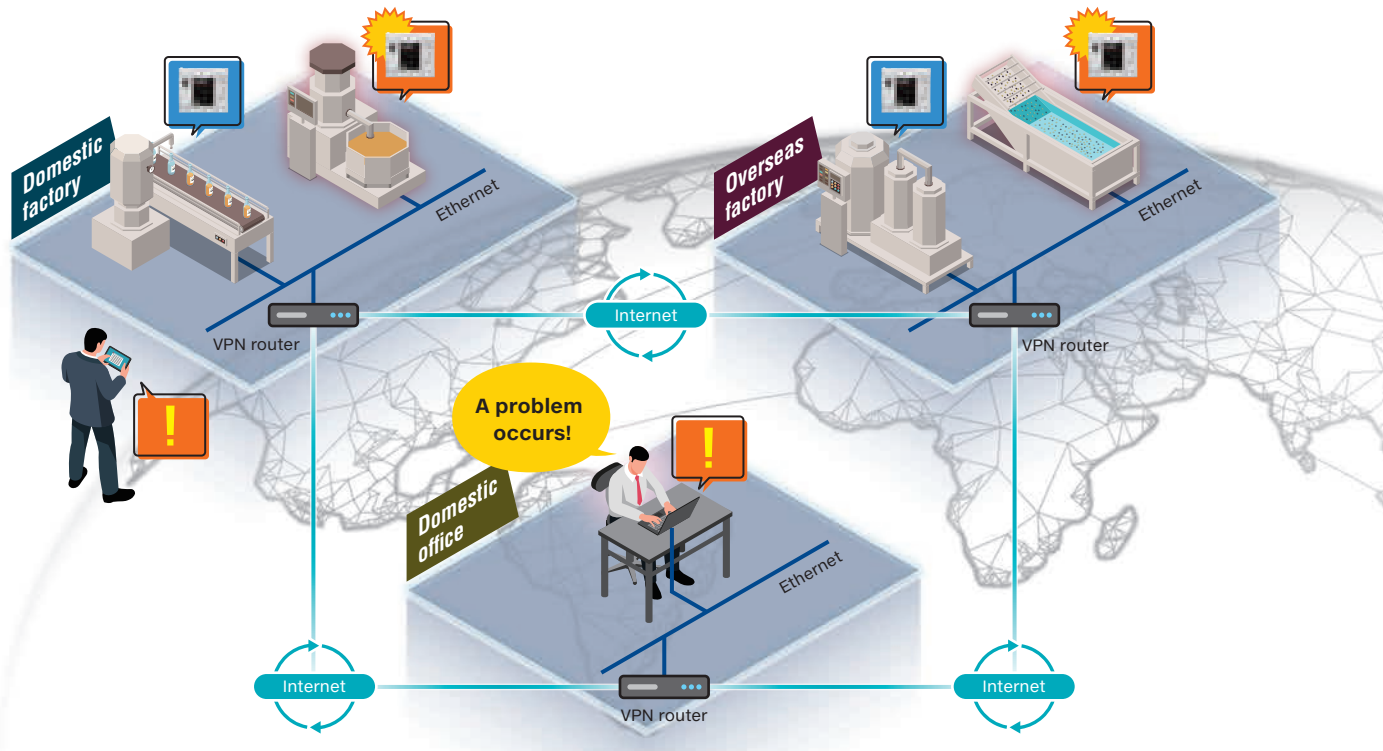

Supported by CPU module. SD memory card module and SD memory card required.

Useful functions

1 Programless communication with other company's PLCs is also possible.

Simple CPU communication function*1

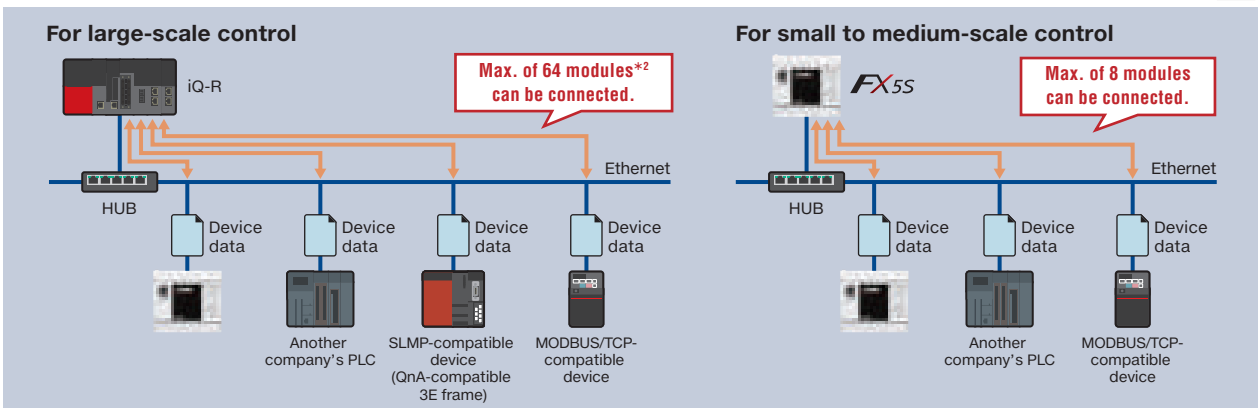

Programless communication can be performed not only with Mitsubishi Electric PLCs, but also with other companies' PLCs. Since device data can be obtained by just setting parameters, it is easy to build a retrofit system.

*1: Supported PLC manufacturers are Mitsubishi Electric, OMRON, Panasonic, KEYENCE, SIEMENS, and others [SLMP-compatible devices (QnA-compatible 3E frame), MODBUS/TCP-compatible devices]. For supported model names, refer to the MELSEC iQ-F FX5 User's Manual (Ethernet Communication).
 *2: When using the iQ-R CPU module's built-in Ethernet port.

Useful functions

2 On-site status can be monitored from a remote office.

Data logging function

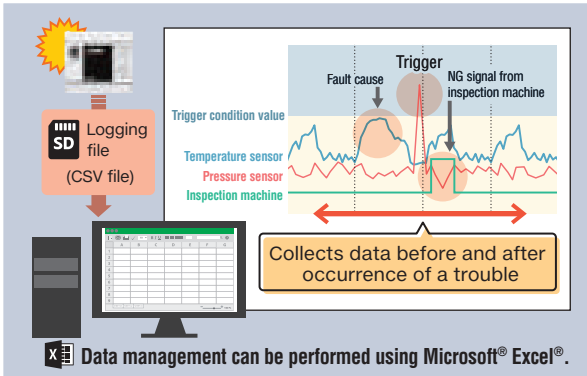

Data logging can be obtained by just setting parameters and no program is required. Data can be stored in a CSV-format file, and data management can be performed easily in Microsoft® Excel®.

File transfer function

(FTP server/FTP client)

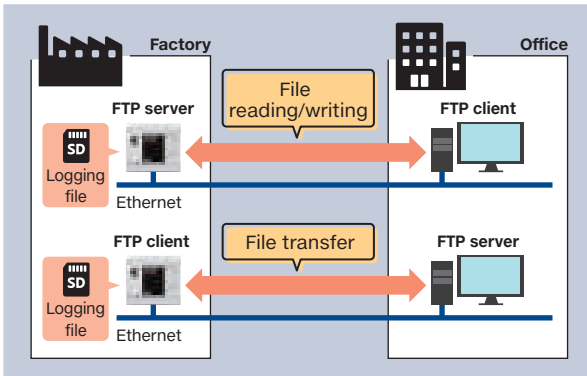

Supports FTP server functions to obtain data at any desired timing and FTP client functions to upload data to a personal computer, etc.

Web server function

System Web page



User Web page

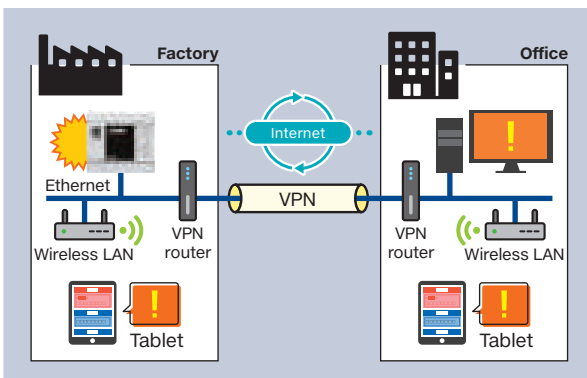

Factory equipment operating status can be checked from a tablet, etc. without any dedicated tools. Customers can also create their own Web page, "User Web page".

Useful functions

3 Enables hassle-free debugging.

Data flow analysis function

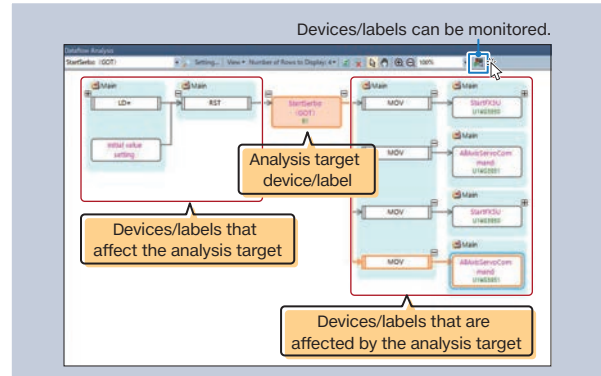

The problematic program location can be quickly found. The program that affects the device/label subject to analysis can be shown graphically, which is useful for cause analysis at the time the error occurred.

Real-time monitor function

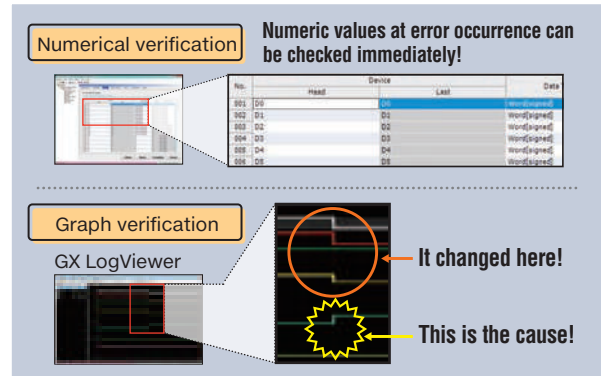

Equipment operation can be visualized. Changes can be noticed at a glance and speedy investigation can be conducted.

Memory dump function

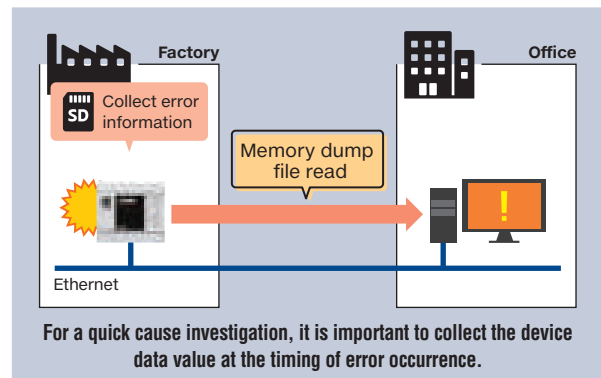

If a trigger is set to be tripped when an error occurs, all device values can be saved at the time the error occurs. This is useful for identifying the cause of the error.

CC-Link IE Field Basic strengthens linking with servos.

FX5S CPU module and MELSERVO-JET can be connected using CC-Link IE Field Network Basic. Higher level drive control is achievable with the FB, that is provided free of charge.

Example of system configuration

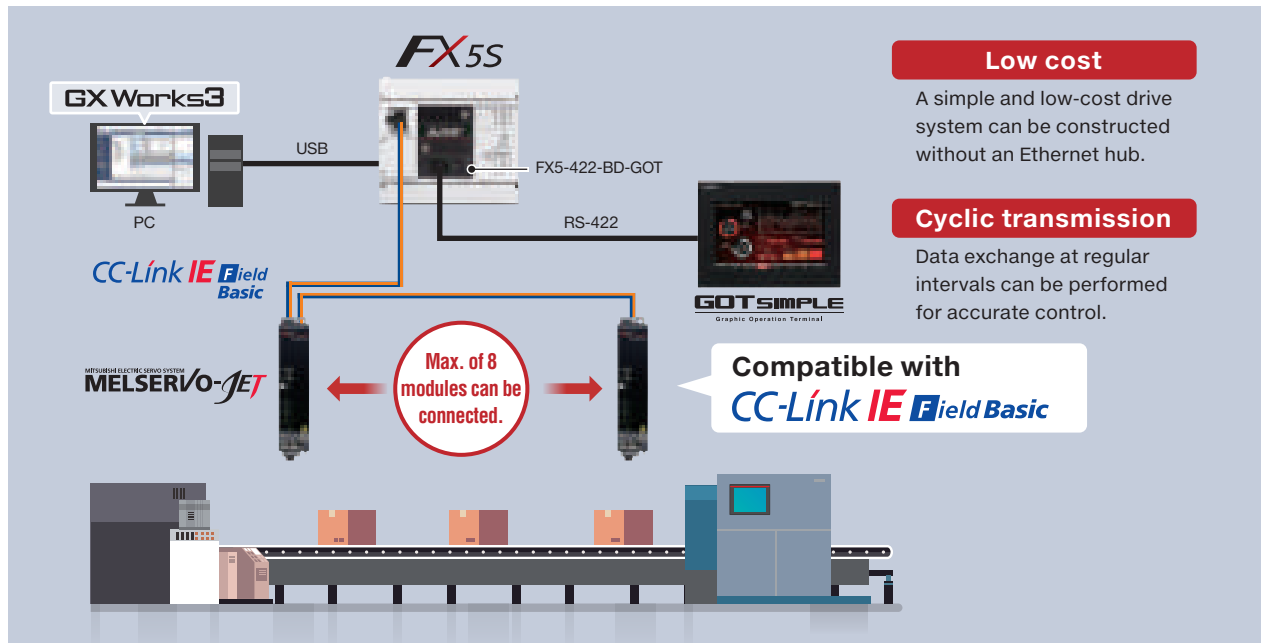

Advanced customer support

+one 1 Quick Connection Guide offers at-a-glance setup procedures.

Setup support

Learn programming procedures

The guide includes an introduction to the devices required for connection, setup procedures for the FX5S CPU module and MELSERVO-JET, and sample program. Follow the procedures for easy setup and connection.

Convenient points

- ✓ Pictures and images make the procedures easy to understand.
- ✓ The guide is offered free of charge.*

Quick Connection Guide
MELSERVO-JET/J5 Series
for CC-Link IE Field Network Basic
L(NA)08840ENG



+one 2 Program support using PLCopen®-compatible FB

Reduces programming labor.

Improves program quality.

International standard PLCopen® Motion Control FB are offered free of charge.* This enables reducing debugging time as well as improving equipment and machinery quality.

Convenient points

- ✓ Using FB makes it easy for even third parties to utilize data.
- ✓ PLCopen® Motion Control FB are offered free of charge.*

A total of 16 types of FB are available.



FB libraries (Example)

Name	Details
MC_Power_CCLinkIEFBasic_F	Switches the status of the servo amplifier for the specified axis to the operable state.
MCv_Home_CCLinkIEFBasic_F	Executes the homing of the specified axis.
MC_Stop_CCLinkIEFBasic_F	Forcibly stops the specified axis.
MC_Halt_CCLinkIEFBasic_F	Stops the specified axis.
MC_MoveAbsolute_CCLinkIEFBasic_F	Specifies the target absolute position of the specified axis and executes positioning.

*: Please contact your local Mitsubishi Electric sales office or representative.

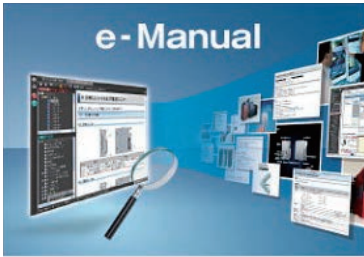

Use e-Manual to view the manual.

"e-Manual", e-book for users of Mitsubishi Electric FA equipment

e-Manual is an e-book that lets FA equipment users quickly obtain the information they need, from product lineup, how to use, etc.

Cross-searching of manuals is possible.



You can search all downloaded manuals at one time. Since you can also narrow down the search to an error code, command, etc., you can quickly find the information you want.

Prevents programming input mistakes.

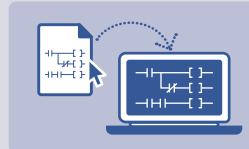

Program samples can be copied with one click and pasted into the engineering tool. This prevents input mistakes.

Please contact your local Mitsubishi Electric sales office or representative.

Compatible with international standards

List of compatible products

○: Compliant with standards or self-declaration □: No need to comply

Model	CE			UL cUL	KC	Ship standards						
	EMC	LVD	RoHS			ABS	DNV	LR	BV	RINA	NK	KR
◆FX5S CPU module												
FX5S-30MR/ES	○	○	○	○	○	—	—	—	—	—	—	—
FX5S-30MT/ES	○	○	○	○	○	—	—	—	—	—	—	—
FX5S-30MT/ESS	○	○	○	○	○	—	—	—	—	—	—	—
FX5S-40MR/ES	○	○	○	○	○	—	—	—	—	—	—	—
FX5S-40MT/ES	○	○	○	○	○	—	—	—	—	—	—	—
FX5S-40MT/ESS	○	○	○	○	○	—	—	—	—	—	—	—
FX5S-60MR/ES	○	○	○	○	○	—	—	—	—	—	—	—
FX5S-60MT/ES	○	○	○	○	○	—	—	—	—	—	—	—
FX5S-60MT/ESS	○	○	○	○	○	—	—	—	—	—	—	—
◆FX5 expansion board												
FX5-SDCD*	○	□	○	—	○	—	—	—	—	—	—	—
FX5-232-BD	○	□	○	—	○	○	○	○	○	○	○	○
FX5-485-BD	○	□	○	—	○	○	○	○	○	○	○	○
FX5-422-BD-GOT	○	□	○	—	○	○	○	○	○	○	○	○
◆FX5 expansion adapter												
FX5-4AD-ADP	○	□	○	○	○	○	○	○	○	○	○	○
FX5-4DA-ADP	○	□	○	○	○	○	○	○	○	○	○	○
FX5-4A-ADP	○	□	○	○	○	—	—	—	—	—	—	—
FX5-4AD-PT-ADP	○	□	○	○	○	○	○	○	○	○	○	○
FX5-4AD-TC-ADP	○	□	○	○	○	○	○	○	○	○	○	○
FX5-232ADP	○	□	○	○	○	○	○	○	○	○	○	○
FX5-485ADP	○	□	○	○	○	○	○	○	○	○	○	○

*: Can be connected only to the FX5S CPU module.

Specifications

External dimensions

2-φ4.5 mounting hole

90

82 (Mounting hole pitches)

15

W1

W

79

8

Model	W (mm)	W1 (mm) Mounting hole pitches	MASS (Weight): kg
FX5S-30M□/ES(S)	100	81	Approx. 0.45
FX5S-40M□/ES(S)	130	111	Approx. 0.55
FX5S-60M□/ES(S)	175	156	Approx. 0.65

External color Main body: Munsell 0.6B7.6/0.2

Unit: mm

51.4

43.6

3.5

11.6

Cut off this part when using together with an expansion board. (for RS-232C/RS-485/RS-422 communication)

MASS (Weight): Approx. 16 g

External color: Munsell N1.5

PROGRAMMABLE CONTROLLERS

MELSEC iQ-F Series

■ General specifications (For details, refer to the manual.)

Item	Specifications
Operating ambient temperature* 1</td <td>0 to 55°C, non-freezing</td>	0 to 55°C, non-freezing
Storage ambient temperature	-25 to 75°C, non-freezing
Operating ambient humidity	5 to 95%RH, non-condensing* 2</td
Storage ambient humidity	5 to 95%RH, non-condensing

*1: For the programmable controllers of the relay output type, there is input/output derating. For details, refer to the manual.

*2: When the product is used in a low-temperature environment, use it in an environment with no sudden temperature changes. If there are sudden temperature changes because of opening/closing of the control panel or other reasons, condensation may occur, which may cause a fire, fault, or malfunction. Use an air conditioner in dehumidifier mode to prevent condensation.

■ Power supply specifications

Item	Specifications		
	FX5S-30M□/ES(S)	FX5S-40M□/ES(S)	FX5S-60M□/ES(S)
Rated voltage	100 to 240 V AC		
Voltage fluctuation range	85 to 264 V AC (-15%, +10%)		
Rated frequency	50/60 Hz		
Allowable instantaneous power failure time	Operation can be continued upon occurrence of instantaneous power failure for 10 ms or less.		
Power fuse	250 V 3.15 A time-lag fuse		
Power consumption* 1</td <td>28 W</td> <td>30 W</td> <td>33 W</td>	28 W	30 W	33 W
Inrush current	30 A max. 5 ms or less/100 V AC 50 A max. 5 ms or less/200 V AC		
Service power supply (24 V DC) capacity* 2</td <td colspan="3">400 mA</td>	400 mA		

*1: This item shows the value when all 24 V DC power supplies are used in the maximum configuration connectable to the CPU module. (The current of the input circuit is included.)

*2: Use this capacity as a power supply for input devices. (Cannot be used as an external power supply for the expansion adapter.)

■ Input specifications (24 V DC input type)

Item	Specifications		
	FX5S-30M□/ES(S)	FX5S-40M□/ES(S)	FX5S-60M□/ES(S)
Input points	16 points	24 points	36 points
Input signal voltage	24 V DC (+20%, -15%)		
Input impedance	X0 to X7	4.3 kΩ	
	X10 and subsequent	5.6 kΩ	
Input signal current	X0 to X7	5.1 mA/24 V DC	
	X10 and subsequent	4.0 mA/24 V DC	
ON input sensitivity current	X0 to X7	3.5 mA or higher	
	X10 and subsequent	3.0 mA or higher	
OFF input sensitivity current	1.5 mA or less		
Input response time	Refer to MELSEC iQ-F FX5S/FX5UJ/FX5U/FX5UC User's Manual (Hardware).		
Input signal type (Input sensor type)	Sink input	No-voltage contact input NPN open collector transistor	
	Source input	No-voltage contact input PNP open collector transistor	
Input operation display	LED on the panel turns on when input turns on.		

■ Output specifications

Relay output

Item	Specifications		
	FX5S-30MR/ES	FX5S-40MR/ES	FX5S-60MR/ES
Output points	14 points	16 points	24 points
External power supply	30 V DC or less 240 V AC or less (Use 250 V AC or less if an external power supply is not CE, UL, or cUL compliant.)		
Maximum load	2 A/point*		
Minimum load	5 V DC 2 mA (reference value)		
Open circuit leakage current	—		
Response time	OFF ↔ ON	Approx. 10 ms	
Output operation display	LED on the panel turns on when output turns on.		

*: The total load current of resistance loads per common terminal should be the following value.
3 output points/common terminal: 6 A or less
4 output points/common terminal: 8 A or less
For the number of outputs per common terminal, refer to the following manual.
→MELSEC iQ-F FX5S/FX5UJ/FX5U/FX5UC User's Manual (Hardware)

⚠ Safety Warning

To ensure proper use of the products in this document, please be sure to read the instruction manual prior to use.

Transistor output

Item	Specifications		
	FX5S-30MT/ES(S)	FX5S-40MT/ES(S)	FX5S-60MT/ES(S)
Output points	14 points	16 points	24 points
Output type	FX5S-□MT/ES	Transistor Sink output	
	FX5S-□MT/ESS	Transistor Source output	
External power supply	5 to 30 V DC		
Maximum load	0.5 A/point*		
Minimum load	—		
Circuit leakage current	0.1 mA or less/30 V DC		
Voltage drop at power-on	Y0 to Y3	1.0 V or less	
	Y4 and subsequent	1.5 V or less	
Response time	OFF ↔ ON	Y0 to Y3	5 μs or less/10 mA or more (5 to 24 V DC)
		Y4 and subsequent	0.2 ms or less/200 mA or more (24 V DC)
Output operation display	LED on the panel turns on when output turns on.		

*: The total load current of resistance loads per common terminal should be the following value.
3 output points/common terminal: 0.6 A or less
4 output points/common terminal: 0.8 A or less
For the number of outputs per common terminal, refer to the following manual.
→MELSEC iQ-F FX5S/FX5UJ/FX5U/FX5UC User's Manual (Hardware)

■ Applicable software package

Software	Applicability
GX Works3	Version 1.080J or later

■ Product list

Types	Model	Rated voltage	Input specifications		Output specifications	
			Point	Input type	Point	Output type
CPU module	FX5S-30MR/ES NEW	100 to 240 V AC	16	24 V DC sink/source	14	Relay
	FX5S-30MT/ES NEW					Transistor/sink
	FX5S-30MT/ESS NEW					Transistor/source
	FX5S-40MR/ES NEW		24		16	Relay
	FX5S-40MT/ES NEW					Transistor/sink
	FX5S-40MT/ESS NEW					Transistor/source
	FX5S-60MR/ES NEW					24
FX5S-60MT/ES NEW	Transistor/sink					
FX5S-60MT/ESS NEW		Transistor/source				
FX5 expansion board	FX5-SDCD* NEW	SD memory card module				
	FX5-232-BD	RS-232C communication expansion board				
	FX5-485-BD	RS-485 communication expansion board				
	FX5-422-BD-GOT	RS-422 communication expansion board (For GOT connection)				
FX5 expansion adapter	FX5-4AD-ADP	4 ch analog input expansion adapter				
	FX5-4DA-ADP	4 ch analog output expansion adapter				
	FX5-4A-ADP	4 ch analog input/output expansion adapter				
	FX5-4AD-PT-ADP	4 ch resistance temperature detector temperature sensor input expansion adapter				
	FX5-4AD-TC-ADP	4 ch thermocouple temperature sensor input expansion adapter				
	FX5-232ADP	RS-232C communication expansion adapter				
FX5-485ADP	RS-485 communication expansion adapter					
Manual	FX5-U-HW-E	MELSEC iQ-F FX5S/FX5UJ/FX5U/FX5UC User's Manual (Hardware) Model code: 09R584				
	FX5-U-EN-E	MELSEC iQ-F FX5 User's Manual (Ethernet Communication) Model code: 09R543				

*: Can be connected only to the FX5S CPU module.

Registration

- Microsoft, Microsoft Access, ActiveX, Excel, SQL Server, Visual Basic, Visual C++, Visual C#, Visual Studio, Windows, Windows NT, Windows Server, Windows Vista, and Windows XP are trademarks of the Microsoft group of companies.
- PLCopen and related logos are registered trademarks of PLCopen®.
- The SD and SDHC logos are trademarks of SD-3C, LLC.
- The company names, system names and product names mentioned in this document are either registered trademarks or trademarks of their respective companies.
- In some cases, trademark symbols such as "™" or "®" are not specified in this document.

MITSUBISHI ELECTRIC CORPORATION

HEAD OFFICE: TOKYO BLDG., 2-7-3, MARUNOUCHI, CHIYODA-KU, TOKYO 100-8310, JAPAN

www.MitsubishiElectric.com